



Abbruchtechnik
Anbaugeräte
Reparatur/Service

Verbaugreifer und

Verbauboxen



Neu im Mietpark



Verbauboxen

Varianten & Größen

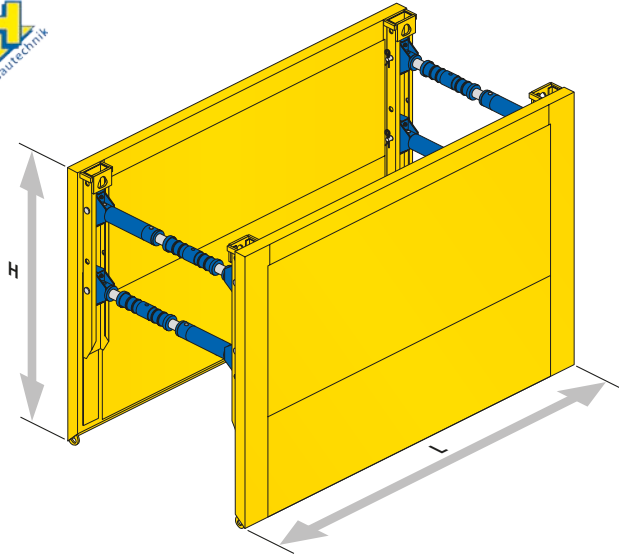

| Plattenlänge L [m] | Plattenhöhe H [m] |
|-----------------------|----------------------|
| 3,00 | 2,40 |
| | 2,60 |
| | 1,40 |
| 3,50 | 2,40 |
| | 2,60 |
| | 1,40 |
| 4,00 | 2,40 |
| | 2,60 |
| | 1,40 |

Verbaugreifer

Varianten & Größen



Länge: 1800 mm / Hub: 600 mm

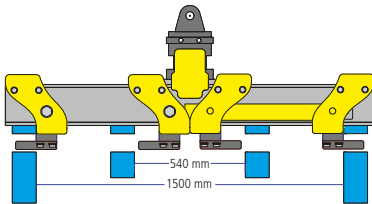

Länge: 2000 mm / Hub: 700 mm

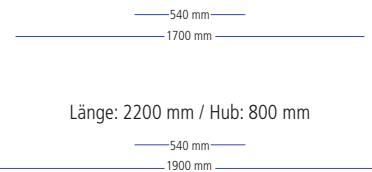

Länge: 2200 mm / Hub: 800 mm

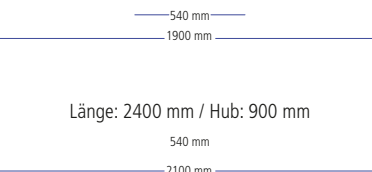

Länge: 2400 mm / Hub: 900 mm

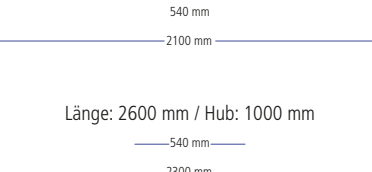

Länge: 2600 mm / Hub: 1000 mm

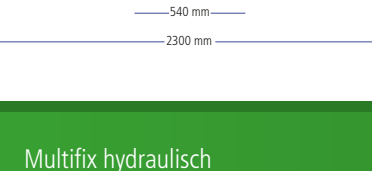

Länge: 1800 mm / Hub: 600 mm

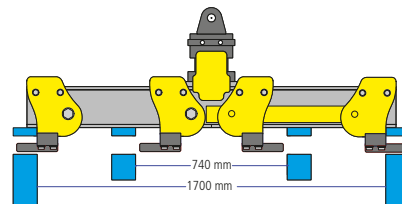

Länge: 2000 mm / Hub: 700 mm

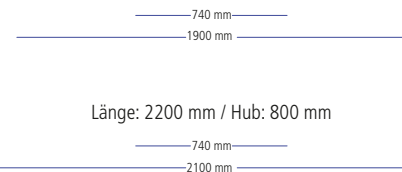

Länge: 2200 mm / Hub: 800 mm

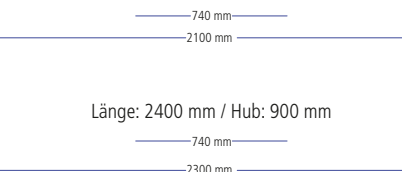

Länge: 2400 mm / Hub: 900 mm

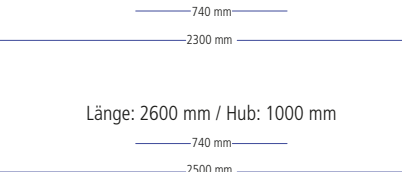

Länge: 2600 mm / Hub: 1000 mm

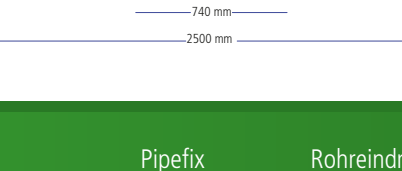

Schmales
Werkzeug

Breites
Werkzeug

HD Rohrgreifer

DN 600 - DN 1300
bzw. DN 1000 - DN 1800



Multifix hydraulisch

DN 300 - DN 1000



Multifix

DN 300 - DN 800
bzw. DN 600 - DN 1000



Pipefix

DN 300 - DN 500



Rohreindrücker



Schachtfix

bis DN 1500



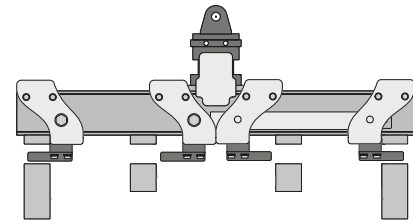
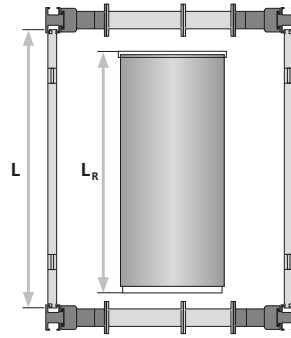
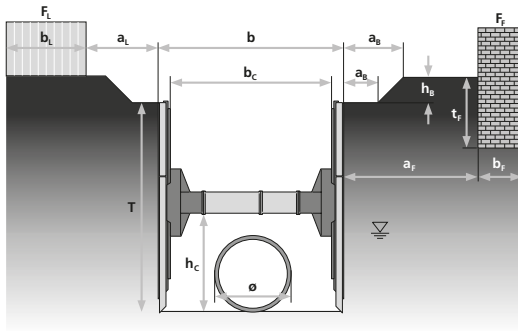

Anschrift

Name, Vorname

Telefon/Fax

Firma

Mobilnummer

Straße, PLZ/Ort

E-Mailadresse

Bauort/Bauvorhaben

VERBAUGREIFER

Schnellwechslersystem

Baggertyp/Größe

VERBAU

Kauf Miete

Plattenlänge

L

Plattenhöhe

H

Anzahl der Felder

n

GRABEN

Grabentiefe

T

Grabentiefe

b

Rohrdurchlasshöhe

h_c

ROHRLEITUNG

Rohrdurchmesser

\emptyset

Rohrlänge

L_R

BÖSCHUNG

Abstand unten

a_B

Abstand oben

a_B

Böschungshöhe

h_B

FUNDAMENT

Fundamentlast

F_F

Fundamentabstand

a_f

Fundamentbreite

b_f

Fundamenttiefe

t_f

VERKEHR

Verkehrslast

F_L

Lastabstand

a_L

Lastbreite

b_L

BODENKENNWERTE

Bohrprofil/Bodenschichtung

Grundwasser

T_w

Wasserabsenkung:

JA

NEIN

Bitte faxen an: +49 (0) 73 05 | 9 50-150

Name, Vorname

Firma

Straße, PLZ/Ort

Telefon/Fax

Mobilnummer

E-Mailadresse

Firmenstempel

- Bitte nehmen Sie persönlichen Kontakt mit mir auf
- Bitte senden Sie mir Infomaterial zu

Ja, ich möchte mehr erfahren über:

- Mietpark für Abbruchtechnik
- Anbaugeräte für Baumaschinen
- Abbruch und Recycling
- Reparatur und Wartung
- Ersatz- und Verschleißteile
- Baustellenzubehör
- Ersatzteile für hydraulische Anbaugeräte
(Für alle gängigen Marken)

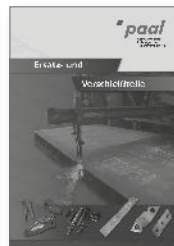

Unsere Partner:



Bitte faxen an: +49 (0) 73 05 | 9 50-150